

Installation Guide

Gigabit Unmanaged Switch

TL-SG1048

TL-SG1024/TL-SG1024D

TL-SG1016/TL-SG1016D

TL-SG1008/TL-SG1008PE

COPYRIGHT & TRADEMARKS

Specifications are subject to change without notice. **TP-LINK®** is a registered trademark of TP-LINK TECHNOLOGIES CO., LTD. Other brands and product names are trademarks of their respective holders.

No part of the specifications may be reproduced in any form or by any means or used to make any derivative such as translation, transformation, or adaptation without permission from TP-LINK TECHNOLOGIES CO., LTD. Copyright © 2016 TP-LINK TECHNOLOGIES CO., LTD. All rights reserved.

<http://www.tp-link.com>

FCC STATEMENT

This equipment has been tested and found to comply with the limits for a Class A digital device, pursuant to part 15 of the FCC Rules. These limits are designed to provide reasonable protection against harmful interference when the equipment is operated in a commercial environment. This equipment generates, uses, and can radiate radio frequency energy and, if not installed and used in accordance with the instruction manual, may cause harmful interference to radio communications. Operation of this equipment in a residential area is likely to cause harmful interference in which case the user will be required to correct the interference at his own expense.

This device complies with part 15 of the FCC Rules. Operation is subject to the following two conditions:

- 1) This device may not cause harmful interference.
- 2) This device must accept any interference received, including interference that may cause undesired operation.

Any changes or modifications not expressly approved by the party responsible for compliance could void the user's authority to operate the equipment.

CE Mark Warning



This is a Class A product. In a domestic environment, this product may cause radio interference, in which case the user may be required to take adequate measures.



Related Document

This Installation Guide is also available in PDF on our website. To obtain the latest documentation and product information, please visit the official website:

<http://www.tp-link.com>

About this Installation Guide

This Installation Guide describes the hardware characteristics, installation methods and the points that should be attended to during the installation. This Installation Guide is structured as follows:

Chapter 1 Introduction. This chapter describes the external components of the switch.

Chapter 2 Installation. This chapter illustrates how to install the switch.

Chapter 3 Lightning Protection. This chapter illustrates how to prevent lightning damage.

Chapter 4 Connection. This chapter illustrates how to do the physical connection of the switch.

Appendix A Troubleshooting.

Appendix B Specifications.

Audience

This Installation Guide is for:



Network Engineer

Network Administrator

Conventions

Due to the similarity in structure of the Gigabit Unmanaged Switch series, in this Installation Guide we take TL-SG1024 as an example to illustrate Chapter 2 Installation, Chapter 3 Lightning Protection and Chapter 4 Connection.

This Guide uses the specific formats to highlight special messages. The following table lists the notice icons that are used throughout this guide.

	Remind to be careful. A caution indicates a potential which may result in device damage.
	Remind to take notice. The note contains the helpful information for a better use of the product.

Contents

Chapter 1	Introduction	01
1.1	Product Overview	01
1.2	Features	01
1.3	Appearance	02
Chapter 2	Installation	08
2.1	Package Contents	08
2.2	Safety Precautions	08
2.3	Installation Tools	10
2.4	Product Installation	11
Chapter 3	Lightning Protection	13
3.1	Cabling Reasonably	13
3.2	Connect to Ground	15
3.3	Equipotential Bonding	16
3.4	Use Lightning Arrester	17
Chapter 4	Connection	19
4.1	Ethernet Port	19
4.2	Verify Installation	19
4.3	Power On	19
4.4	Initialization	20
Appendix A	Troubleshooting	21
Appendix B	Specifications	22

Chapter 1 Introduction

1.1 Product Overview

The Gigabit Unmanaged Switch provides you with a high-performance, low-cost, easy-to-use, seamless and standard upgrade to boost your old network to 1000Mbps. By increasing the speed of your network server and backbone connections, the Gigabit Unmanaged Switch makes Gigabit a reality. Power users in the home, office, workgroup, or creative production environment can now move large, bandwidth-intensive files faster. Graphics, CGI, CAD, multimedia files and other large files moved by some applications can be transferred across the network almost instantly.

The Gigabit Unmanaged Switch features a non-blocking switching architecture that forwards and filters packets at full wire-speed for maximum throughput. The switch supports MAC address auto-learning and auto-aging. It is compatible with all 10Mbps, 100Mbps and 1000Mbps Ethernet devices because it is standard-based. It protects your existing network investments while providing you with a straightforward migration path to faster Gigabit speed.

The Gigabit Unmanaged Switch is plug-and-play and no configuration is required. Auto MDI/MDI-X cable detection on all ports eliminates the need for crossover cable or Uplink port. Each port can be used as general port or Uplink port, and any port can be simply plugged into a server, a hub, a router or a switch, using the straight cable or crossover cable. Diagnostic LEDs which display link status and activity, allow you to quickly detect and correct problems on the network.

TL-SG1008PE is a Power Sourcing Equipment (PSE*). The 8 Auto-Negotiation RJ45 ports support Power over Ethernet (PoE*) function, which can automatically detect and supply power with those IEEE802.3af/IEEE802.3at-compliant powered devices (PDs*).



Note:

- *PSE is a device (switch or hub for instance) that will provide power in a PoE setup.
 - *PoE is a technology that describes a system to transmit electrical power, along with data, to remote devices over standard twisted-pair cable in an Ethernet network.
 - *PD is a device powered by a PSE and thus consumes energy. Examples include powering IP telephones, wireless LAN access points, network cameras, network hubs, embedded computers etc.
-

1.2 Features

For TL-SG1048/TL-SG1024/TL-SG1024D/TL-SG1016/TL-SG1016D/TL-SG1008:

- Complies with IEEE802.3i, IEEE802.3u, IEEE802.3ab standards
- 8/16/24/48 10/100/1000Mbps Auto-Sense RJ45 ports supporting Auto-MDI/MDIX
- All ports support Full/Half Duplex transfer mode for 10/100Mbps and Full Duplex transfer mode for 1000Mbps

- TL-SG1024/TL-SG1024D/TL-SG1016/TL-SG1016D/TL-SG1008 supports IEEE802.3x flow control for full-duplex mode and backpressure for half-duplex transfer mode
- TL-SG1008 supports IEEE802.1p standard
- Non-blocking switching architecture that forwards and filters packets at full wire-speed for maximum throughput
- Supports MAC address auto-learning and auto-aging
- Desktop and rack-mountable steel case
- Internal power supply

For TL-SG1008PE:

- Complies with IEEE802.3i, IEEE802.3u, IEEE802.3ab, IEEE802.3x, IEEE802.3af, IEEE802.1p and IEEE802.3at standards
- 8 10/100/1000Mbps Auto-Negotiation RJ45 ports all supporting PoE function and Auto-MDI/MDIX
- Supports PoE power up to 126W for all PoE ports
- Supports PoE IEEE802.3af/IEEE802.3at-compliant PDs
- Supports IEEE802.3x flow control for Full-duplex Mode and backpressure for Half-duplex Mode
- 4K MAC address table of the TL-SG1008PE with auto-learning and auto-aging
- Internal power supply

1.3 Appearance

■ Front Panel

The front panel of TL-SG1048 is shown as the following figure.

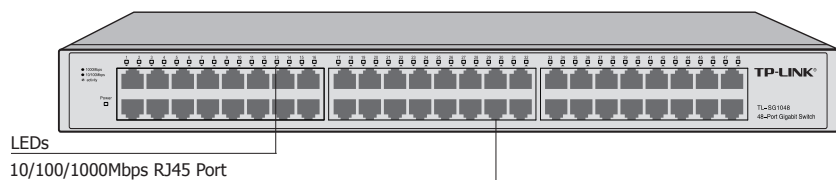

Figure 1-1 Front Panel of TL-SG1048

LEDs

LED	Status	Indication	
Power	On	The switch is powered on.	
	Off	The switch is powered off or power supply is abnormal.	
Link/Act	On	Green	The corresponding port is running at 1000Mbps.
		Yellow	The corresponding port is running at 10/100Mbps.
	Flashing	The corresponding port is transmitting or receiving data.	
	Off	There is no device linked to the corresponding port.	

10/100/1000Mbps RJ45 Port

Designed to connect to the device with a bandwidth of 10Mbps, 100Mbps or 1000Mbps. Each has a corresponding Link/Act LED.

The front panel of TL-SG1024 is shown as the following figure.

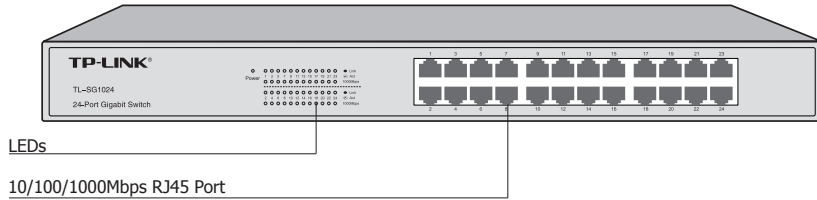

Figure 1-2 Front Panel of TL-SG1024

The front panel of TL-SG1016 is shown as the following figure.

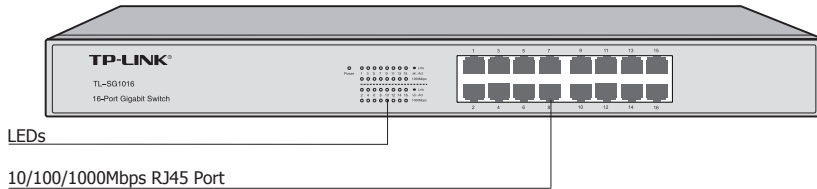

Figure 1-3 Front Panel of TL-SG1016

The front panel of TL-SG1024D is shown as the following figure.

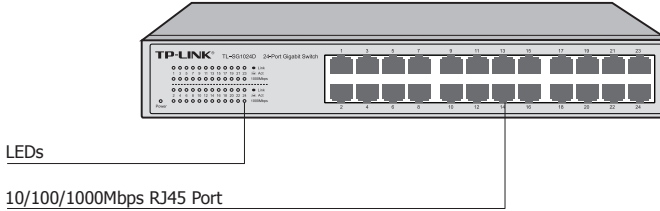

Figure 1-4 Front Panel of TL-SG1024D

The front panel of TL-SG1016D is shown as the following figure.

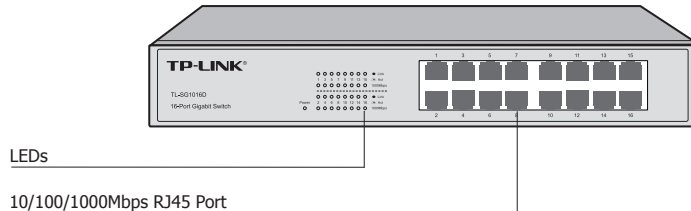

Figure 1-5 Front Panel of TL-SG1016D

The front panel of TL-SG1008 is shown as the following figure.

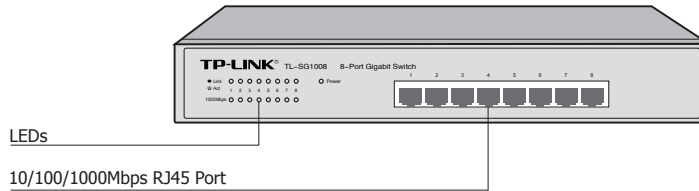

Figure 1-6 Front Panel of TL-SG1008

LEDs

LED	Status	Indication
Power	On	The switch is powered on.
	Off	The switch is powered off or power supply is abnormal.
Link/Act	On	There is a device linked to the corresponding port but no activity.
	Flashing	The corresponding port is transmitting or receiving data.
	Off	There is no device linked to the corresponding port.
1000Mbps	On	The corresponding port is running at 1000Mbps.
	Off	The corresponding port is not running at 1000Mbps or has no link.

10/100/1000Mbps RJ45 Port

Designed to connect to the device with a bandwidth of 10Mbps, 100Mbps or 1000Mbps. Each has a corresponding Link/Act LED and a 1000Mbps LED.

The front panel of TL-SG1008PE is shown as the following figure.

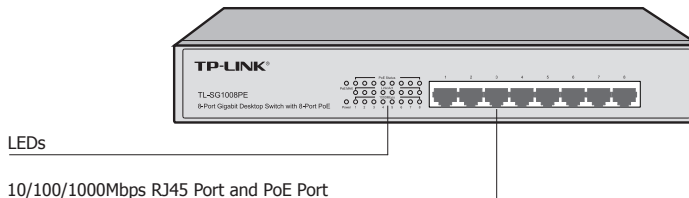

Figure 1-7 Front Panel of TL-SG1008PE

LEDs

LED	Status	Indication
Power	On (green)	The switch is powered on.
	Flashing (green)	Power supply is abnormal.
	Off	The switch is powered off.
Link/Act	On (green)	A valid link is established on the port.
	Flashing (green)	The corresponding port is transmitting or receiving data.
	Off	There is no device linked to the corresponding port.

LED	Status	Indication
PoE MAX	On (red)	The power of all the connected PoE ports is between 120W and 126W. No power may be supplied if additional PDs are connected.
	Flashing (red)	The power of all the connected PoE ports is $\geq 126W$.
	Off	The power of all the connected PoE ports is $< 120W$, or there is no PD connected to the corresponding port.
1000Mbps	On (green)	The corresponding port is running at 1000Mbps.
	Off	The corresponding port is not running at 1000Mbps or has no link.
PoE Status	On (green)	There is a PoE PD connected to the port, which supplies power successfully.
	Flashing (green)	The PoE power circuit may be in short or the power current may be overloaded.
	Off	No PD is connected to the corresponding port, or no power is supplied according to the power limits of the port.

10/100/1000Mbps RJ45 Port and PoE Port

TL-SG1008PE switch is equipped with 8 10/100/1000Mbps Auto-Negotiation RJ45 ports and all of them support PoE function.

The 8 10/100/1000Mbps RJ45 ports are designed to connect to the device with a bandwidth of 10Mbps, 100Mbps or 1000Mbps. Once the network devices are connected to these 8 ports through the network cable, the switch will make them plug and play according to the Auto-MDI/MDIX detection. The working status can be indicated by the Link/Act LEDs and 1000Mbps LEDs on the front panel.

The 8 ports also support PoE function which integrates power and data onto one Ethernet cable. Once the device you connect to the switch is identified, the switch will supply power through the PoE port, and then you can use it as a 10/100/1000Mbps Auto-Negotiation RJ45 Ethernet port. The working status can be indicated by the PoE MAX LED and PoE Status LEDs on the front panel.

Note:



- If all PoE PDs power consumption is $\geq 126W$, a priority* will be arranged among the PoE ports like port 1 > port 2 > port 3 > port 4 > port 5 > port 6 > port 7 > port 8, then the system will cut off the power of the lowest-priority port.
- *Priority is to protect the system when the system power is overloaded. For example, Port 1, 2, 4 and 7 is using 30; the system power is 120W in total. If there is an additional PD inserted to Port 3 with 25W, and then the system will cut off the power of Port 7 because of the overloaded power, this means Port 1, 2 and 4 will use 30W, and Port 3 will use 25W, no power will be supplied to Port 7.
- Make sure the PDs you connected to the switch are compliant with IEEE802.3af/IEEE802.3at standard.

Rear Panel

The rear panel of TL-SG1048 is shown as the following figure.

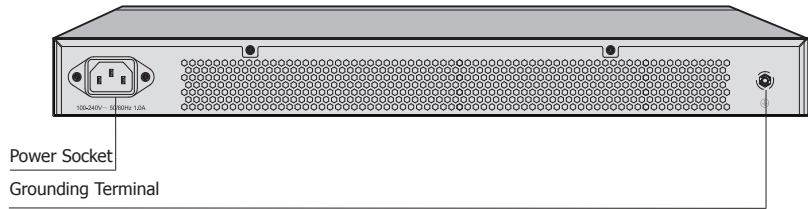

Figure 1-8 Rear Panel of TL-SG1048

The rear panel of TL-SG1024 is shown as the following figure.

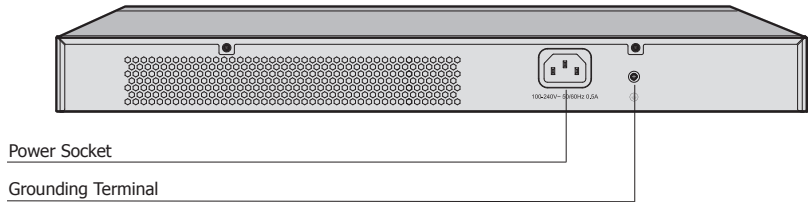

Figure 1-9 Rear Panel of TL-SG1024

The rear panel of TL-SG1016 is shown as the following figure.

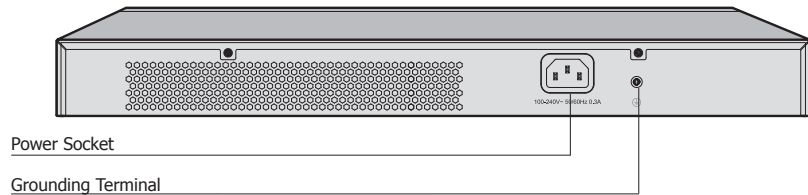

Figure 1-10 Rear Panel of TL-SG1016

The rear panel of TL-SG1024D is shown as the following figure.

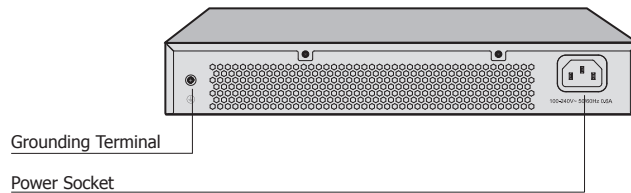

Figure 1-11 Rear Panel of TL-SG1024D

The rear panel of TL-SG1016D is shown as the following figure.

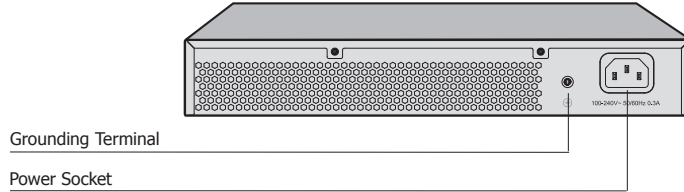

Figure 1-12 Rear Panel of TL-SG1016D

The rear panel of TL-SG1008 is shown as the following figure.

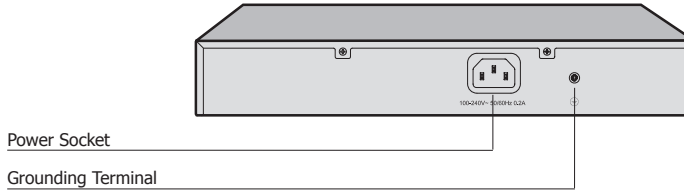

Figure 1-13 Rear Panel of TL-SG1008

The rear panel of TL-SG1008PE is shown as the following figure.

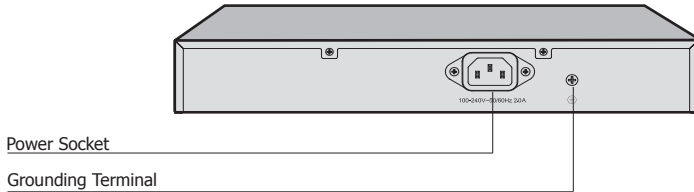

Figure 1-14 Rear Panel of TL-SG1008PE

Power Socket

Connect the female connector of the power cord here, and the male connector to the AC (Alternating Current) power outlet. Please make sure the voltage of the power supply meets the requirement of the input voltage.

Grounding Terminal

The switch already comes with lightning protection mechanism. You can also ground the switch through the PE (Protecting Earth) cable of AC cord or with Ground Cable. For detailed information, please refer to **Chapter 3 Lightning Protection**.



Caution: Please use the provided power cord.

Chapter 2 Installation

2.1 Package Contents

Make sure that the package contains the following items. If any of the listed items is damaged or missing, please contact your distributor.

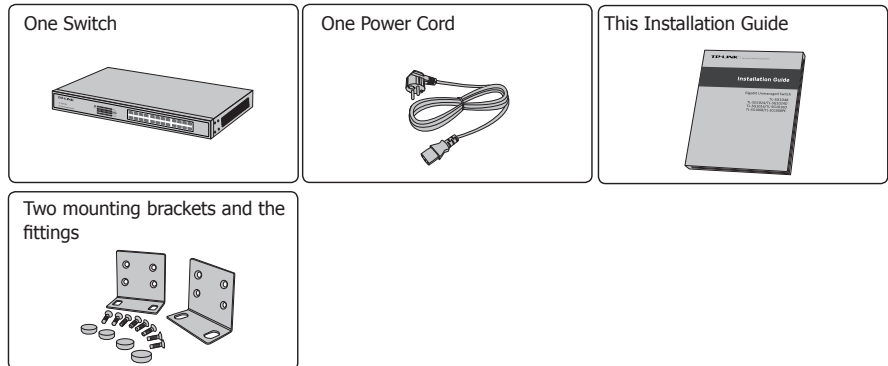

2.2 Safety Precautions

To avoid any device damage and bodily injury caused by improper use, please observe the following rules.

■ Safety Precautions

- Keep the power off during the installation.
- Wear an ESD-preventive wrist strap, and make sure that the wrist strap has a good skin contact and is well grounded.
- Use only the power cord provided with the switch.
- Make sure that the supply voltage matches the specifications indicated on the rear panel of the switch.
- Ensure the vent hole is well ventilated and unblocked.
- Do not open or remove the cover of the switch.
- Before cleaning the device, cut off the power supply. Do not clean it by the waterish cloth, and never use any other liquid cleaning method.

■ Site Requirements

Temperature/Humidity



Please keep a proper temperature and humidity in the equipment room. Too high/low humidity may lead to bad insulation, electricity leakage, mechanical property changes and corrosions. Too high temperature may accelerate aging of the insulation materials and can thus significantly shorten the service life of the device. For normal temperature and humidity of the device, please check the following table.

Environment	Temperature	Humidity
Operating	0°C ~ 40°C	10% ~ 90%RH Non-condensing
Storage	-40°C ~ 70°C	5% ~ 90%RH Non-condensing

Cleanness



The dust accumulated on the switch can be absorbed by static electricity and result in poor contact of metal contact points. Some measures have been taken for the device to prevent static electricity, but too strong static electricity can cause deadly damage to the electronic elements on the internal circuit board. To avoid the effect of static electricity on the operation of the Switch, please attach much importance to the following items:

- Dust the device regularly, and keep the indoor air clean.
- Keep the device well grounded and ensure static electricity has been transferred.

Electromagnetic Interference



Electronic elements including capacitance and inductance on the device can be affected by external interferences, such as conducted emission by capacitance coupling, inductance coupling, and impedance coupling. To decrease the interferences, please make sure to take the following measures:

- Use the power supply that can effectively filter interference from the power grid.
- Keep the device far from high-frequency, strong-current devices, such as radio transmitting station.
- Use electromagnetic shielding when necessary.

Lightning Protection



Extremely high voltage currents can be produced instantly when lightning occurs and the air in the electric discharge path can be instantly heated up to 20,000°C. As this instant current is strong enough to damage electronic devices, more effective lightning protection measures should be taken.

- Ensure the rack and device are well earthed.
- Make sure the power socket has a good contact with the ground.
- Keep a reasonable cabling system and avoid induced lightning.
- Use the signal SPD (Surge Protective Device) when wiring outdoor.



Note: For detailed lightning protection measures, please refer to **Chapter 3 Lightning Protection**.

Installation Site

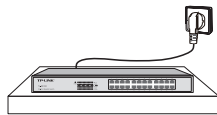

When installing the device on a rack or a flat workbench, please note the following items:

- The rack or workbench is flat and stable, and sturdy enough to support the weight of 5.5kg at least.
- The rack or workbench has a good ventilation system. The equipment room is well ventilated.
- The rack is well grounded. Keep the power socket less than 1.5 meters away from the device.

2.3 Installation Tools

- Phillips screwdriver
- ESD-preventive wrist wrap
- Cables



Note: These tools are not provided with our product. If needed, please self purchase them.

2.4 Product Installation

■ Desktop Installation

To install the device on the desktop, please follow the steps:

1. Set the device on a flat surface strong enough to support the entire weight of the device with all fittings.
2. Remove the adhesive backing papers from the rubber feet.
3. Turnover the device and attach the supplied rubber feet to the recessed areas on the bottom at each corner of the device.

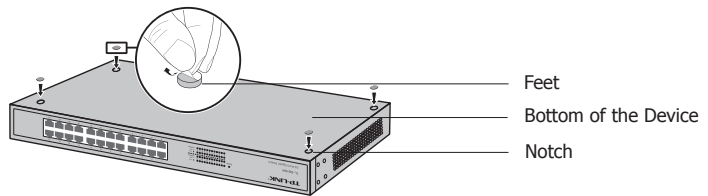

Figure 2-1 Desktop Installation

■ Rack Installation

To install the device in an EIA standard-sized, 19-inch rack, follow the instructions described below:

1. Check the grounding and stability of the rack.
2. Secure the supplied rack-mounting brackets to each side of the device with supplied screws, as illustrated in the following figure.

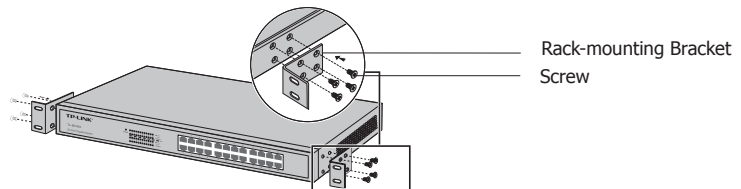

Figure 2-2 Bracket Installation

3. After the brackets are attached to the device, use suitable screws (not provided) to secure the brackets to the rack, as illustrated in the following figure.

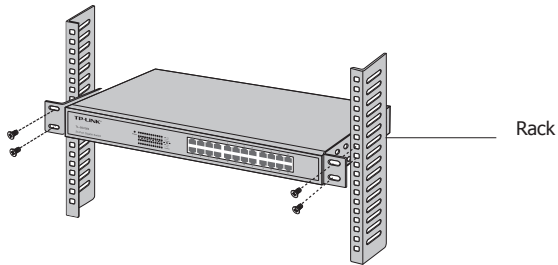

Figure 2-3 Rack Installation

**Caution:**

- Please set 5~10cm gaps around the device for air circulation.
- Please avoid any heavy thing placed on the device.
- Please mount devices in sequence from the bottom to top of the rack and ensure a certain clearance between devices for the purpose of heat dissipation.

Chapter 3 Lightning Protection

3.1 Cabling Reasonably

In the actual network environment, you may need cable outdoors and indoors, and the requirements for cabling outdoors and indoors are different. A reasonable cabling system can decrease the damage of induced lightning to devices.



Note: It's not recommended using Ethernet cables outdoors. When cabling outdoors, please use a signal lightning arrester.

■ Requirements for Cabling Outdoors

- Aerial cabling without safeguard is not allowed.

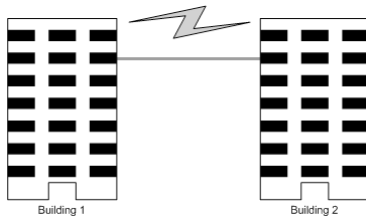

- It's not allowed cabling down the building to connect network devices in different floors.

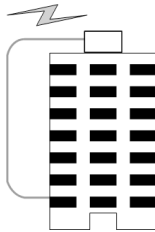

- Outdoor cables should be buried and paved to the indoor through basement. A piece of steel wire should be paved underground along the pipe and connected to the lightning protection terminal of the building for shielding. Before connecting the cable to the device, install a signal lightning arrester on the corresponding port.
- When an aerial cable is set up, the cable should be through a metal pipe (15m long at least) before coming into the building. The two ends of this metal pipe should be grounded. Before connecting the cable to the device, install a signal lightning arrester on the corresponding port.
- It's not necessary to pave STP cables through pipes. The shielded layer of STP cable should be well grounded. Before connecting the cable to the device, install a signal lightning arrester on the corresponding port.

■ Requirements for Cabling Indoors

When cabling indoors, keep a certain distance away from the devices that may cause high-frequency interferences, such as down-conductor cable, powerline, power transformer and electromotor.

- The main cable should be paved in the metal raceway of the access shaft. When cabling, keep the loop area formed by the cable itself as small as possible.
- Requirements for the distance between Ethernet cable and other pipelines are shown in the table.

Other Pipelines	Ethernet Cable	
	Min Parallel Net Length L (mm)	Min Parallel-overlapping Net Height H (mm)
Down-conductor	1000	300
PE	50	20
Service pipe	150	20
Compressed air pipe	150	20
Thermal pipe (not wrapped)	500	500
Thermal pipe (wrapped)	300	300
Gas pipe	300	20

The two diagrams below demonstrate parallel net length and parallel-overlapping net height.

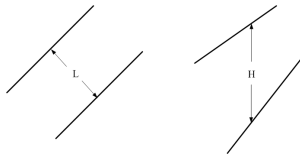

Note: The above minimum net length/height is required when metal raceway is not used. If any requirements cannot be met, you can add a steel tube or metal raceway for shielding.

- Requirements for the distance between Ethernet cable and high-power electric devices are in following tables.

Cable	Pave Way	Min Parallel Length (mm)
<2kVA powerline	Parallel cabling	130
	One is in the grounded metal raceway or metal pipe	70
	The both are in the grounded metal raceway or metal pipe	10

Cable	Pave Way	Min Parallel Length (mm)
2~5kVA powerline	Parallel cabling	300
	One is in the grounded metal raceway or metal pipe	150
	The both are in the grounded metal raceway or metal pipe	80
>5kVA powerline	Parallel cabling	600
	One is in the grounded metal raceway or metal pipe	300
	The both are in the grounded metal raceway or metal pipe	150

Device	Min Distance (m)
Switch case	1.00
Transformer room	2.00
Elevator tower	2.00
Air-conditioner room	2.00

3.2 Connect to Ground

Connecting the device to ground is to quickly release the lightning over-voltage and over-current of the device, which is also a necessary measure to protect the body from electric shock.

In different environments, the device may be grounded differently. The following will instruct you to connect the device to the ground in two ways, connecting to the grounding bar or connecting to the ground via the power cord. Please connect the device to ground in the optimum way according to your specific operation environment.

■ Connecting to the Grounding Bar

If the device is installed in the Equipment Room, where a grounding bar is available, you are recommended to connect the device to the grounding bar as shown in the following figure.

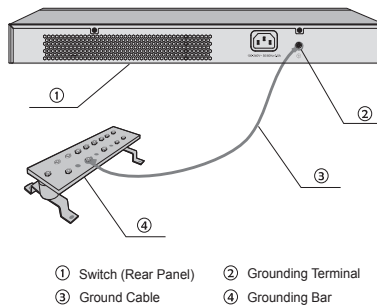

Figure 3-1 Connecting to the Grounding Bar



Note: The grounding bar and the ground cable are not provided with our product. If needed, please self purchase them.

■ Connecting to the Ground via the Power Supply

If the device is installed in the normal environment, the device can be grounded via the PE (Protecting Earth) cable of the AC power supply as shown in the following figure.

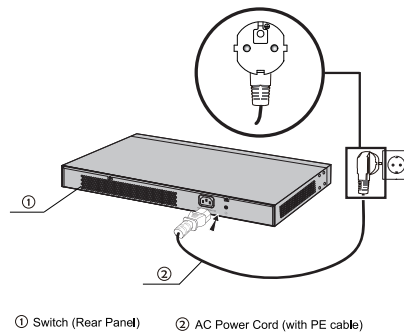

Figure 3-2 Connecting to the Ground



Note:

- The figure is to illustrate the application and principle. The power plug you get from the package and the socket in your situation will comply with the regulation in your country, so they may differ from the figure above.
- If you intend to connect the device to the ground via the PE (Protecting Earth) cable of AC power cord, please make sure the PE (Protecting Earth) cable in the electrical outlet is well grounded in advance.

3.3 Equipotential Bonding

Equipotential Bonding is the practice of intentionally electrically connecting all earthed systems to the same grounding grid or connecting the grounding grids of all the earthed systems together through the ground or overground metal so as to create an earthed equipotential zone. When lightning occurs, the high voltage produced by lightning current in all systems will meanwhile exist in their ground cables, and thus all ground cables have the same electrical potential and basically eliminate the electric strikes between the systems.

The figure below illustrates how to practice equipotential bonding in a network.

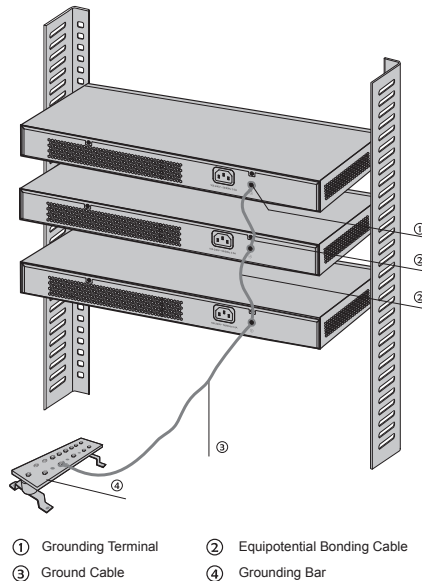

Figure 3-3 Equipotential Bonding

When equipotential bonding, please note that the cable should be copper wrapped Kelly with its area being 6mm^2 at least. The shorter cable the better, and use a grounding bar to establish an equipotential bonding point.



Note: The equipotential bonding cable and ground cable are not provided with our product. If needed, please self purchase it.

3.4 Use Lightning Arrester

Power lightning arrester and signal lightning arrester are used for lightning protection.

Power lightning arrester is used for limiting the voltage surge due to a lightning. If an outdoor AC power cord should be directly connected to the device, please use a power lightning arrester.



Note: Power lightning arrester is not provided with our product. If needed, please self purchase it.

Signal lightning arrester is used to protect RJ45 ports of the device from lightning. When cabling outdoors, please install a signal lightning arrester before connecting the cable to the device.

When purchasing or using a signal lightning arrester, please observe the following rules:

- The port rate of the signal lightning arrester should match the rate of the desired port on the device. If it is not matched, this signal lightning arrester will not work. Purchase a standard lightning arrester.
- Install signal lightning arrester near the protected device and connect it to the ground via a shorter ground cable.

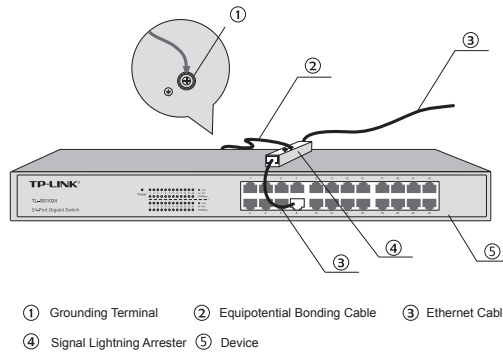

Figure 3-4 Equipotential Bonding



Note: Signal lightning arrester is not provided with our product. If needed, please self purchase it.

Chapter 4 Connection

4.1 Ethernet Port

Connect a Ethernet port of the switch to the computer by RJ45 cable as the following figure shows.

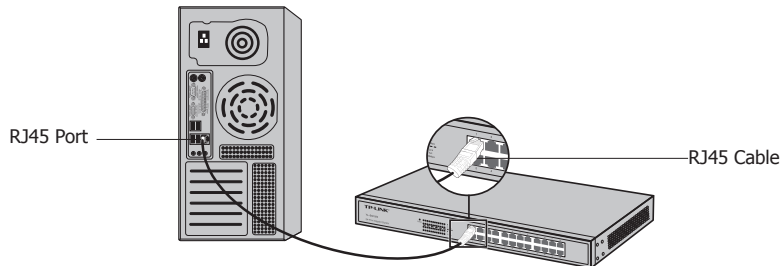

Figure 4-1 Connecting the RJ45 Port

4.2 Verify Installation

After completing the installation, please verify the following items:

- There are 5~10cm of clearance around the sides of the device for ventilation and the air flow is adequate.
- The voltage of the power supply meets the requirement of the input voltage of the device.
- The power socket, device and rack are well grounded.
- The device is correctly connected to other network devices.

4.3 Power On

Plug in the negative connector of the provided power cord into the power socket of the device, and the positive connector into a power outlet as the following figure shows.

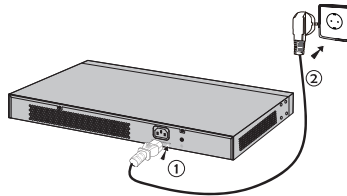

Figure 4-2 Connecting to Power Supply



Note: The figure is to illustrate the application and principle. The power plug you get from the package and the socket in your situation will comply with the regulation in your country, so they may differ from the figure above.

4.4 Initialization

For TL-SG1048/TL-SG1024/TL-SG1024D/TL-SG1016/TL-SG1016D/TL-SG1008:

After the device is powered on, it begins the Power-On Self-Test. A series of tests run automatically to ensure the device functions properly. During this time, its LED indicators will respond as follows:

- All of the LED indicators will flash momentarily for one second, which represents a resetting of the system.
- The Power LED indicator will light up.

For TL-SG1008PE:

The LED indicators for TL-SG1008PE are classified into two parts:

the LEDs indicating switch status including Power LED, Link/Act LEDs and 1000Mbps LEDs; the LEDs indicating PSE status, including PoE MAX LED and PoE Status LEDs.

After the device is powered on, it begins the Power-On Self-Test. A series of tests run automatically to ensure the device functions properly. During this time, its LED indicators will respond as follows:

- All of the LEDs indicating switch status will flash momentarily for one second, which represents a resetting of the switch system. The PoE MAX LED will keep on for approximately ten seconds, representing a resetting of the PSE system. Take note that the PoE Status LEDs won't light up during this period.
- The Power LED indicator will light up.

Appendix A Troubleshooting

Q1. The Power LED is not lit

The Power LED should be lit up when the power system works normally. If the Power LED worked abnormally, please check as follows:

1. Make sure that the power cable is connected properly, and the power contact is normal.
2. Make sure the voltage of the power supply meets the requirement of the input voltage of the switch.

Q2. The Link/Act LED is not lit when a device is connected to the corresponding port

Please check as follows:

1. Make sure that the cable connectors are firmly plugged into the switch and the device.
2. Make sure the connected device is turned on and working well.
3. The cable must be less than 100 meters long (328 feet).

- For more troubleshooting help, go to: <http://www.tp-link.com/en/support/faq>
- To download the latest Firmware, Driver, Utility and User Guide, go to: <http://www.tp-link.com/en/support/download>

Appendix B Specifications

Item	Content
Standards	IEEE802.3i, IEEE802.3u, IEEE802.3ab
	IEEE802.3x (except TL-SG1048)
	IEEE802.1p (for TL-SG1008PE/TL-SG1008)
	IEEE802.3af (for TL-SG1008PE), IEEE802.3at (for TL-SG1008PE)
Transmission Medium	10Base-T UTP/STP of Cat. 3 or above(maximum 100m)
	100Base-TX 2-pair UTP/STP of Cat. 5 or above (maximum 100m)
	1000Base-T 4-pair UTP/STP of Cat. 5e or above (maximum 100m)
Safety & Emissions	FCC, CE
Protocol	CSMA/CD
PoE Power on RJ45	For TL-SG1008PE: Power+: pin 3 & pin 6 Power -: pin 1 & pin 2
Transfer Method	Store-and-Forward
MAC Address Learning	Automatically learning, automatically aging
Frame Forward Rate	10Base-T: 14881pps/Port
	100Base-Tx: 148810pps/Port
	1000Base-T: 1488095pps/Port
LEDs	Power, Link/Act (TL-SG1048)
	Power, Link/Act, 1000Mbps (TL-SG1024/TL-SG1024D/TL-SG1016/TL-SG1016D/TL-SG1008)
	Power, PoE MAX, 1000Mbps, Link/Act, PoE Status (TL-SG1008PE)
Operating Temperature	0°C~40°C (32 ~104°F)
Storage Temperature	-40°C~70°C (-40 ~158°F)
Operating Humidity	10%~90%RH Non-condensing
Storage Humidity	5%~90%RH Non-condensing

TP-LINK[®]
The Reliable Choice

Website: <http://www.tp-link.com> E-mail: support@tp-link.com

7106506251 REV5.3.0